



キノコマン

NBMC_13 BROCKEN JR. ブロッケン Jr.

△WARNING: CHOKING HAZARD - small parts. Not for children under 3 years old.
小さな部品が含まれますので、3歳未満のお子様には与えないでください。

©ゆでたまご・東映アニメーション
©KAWADA 2020



ご見様がございましたら、お客様サービス課までご連絡ください。
カワダ 長野工場 お客様サービス課
〒389-0514 長野県東御市加沢1409 TEL:0268(62)1819
電話受付時間：土日祝日を除く 9～12時・13～16時

20 AU
KK
HM
G1620

発売元 株式会社 カワダ
〒169-8558 東京都新宿区大久保 2-5-25
http://www.diablock.co.jp/nanoblock/

※別売りの「NB-019 ナノブロック専用ピンセット」や「NB-020 ナノブロックパッド」を使うと組み立て、取りはずしに便利です。
Use "NB-019 nanoblock® Tweezers" and "NB-020 nanoblock® Pad" (each sold separately) for an easy way to assemble and disassemble blocks.

- Bronze Green (ブロンズグリーン): 9x1, 5x1, 3x1, 2x1, 2x2, 3x2, 3x3, 2x2, 4x1, 4x2, 4x4
- Emerald Green (エメラルドグリーン): 2x2, 1x1, 4x1, 1x1, 2x2, 1x1, 4x1, 1x1
- Red: 5x1, 2x1, 4x1
- Black: 5x1, 2x1, 6x1
- Grey: 2x2, 4x4, 4x1, 1x1

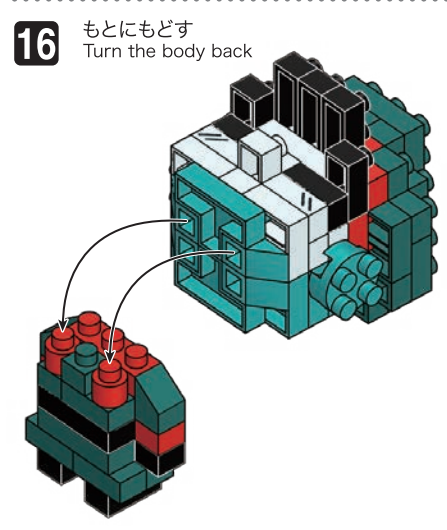
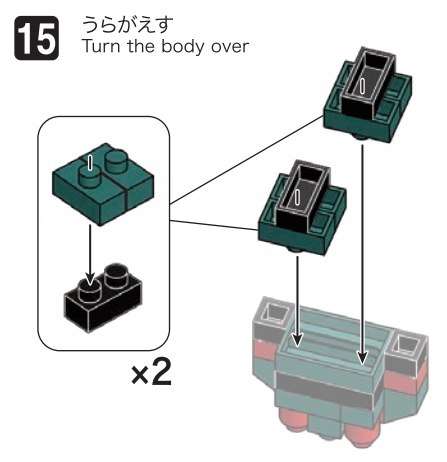
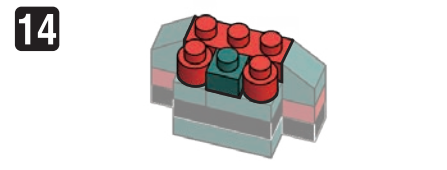
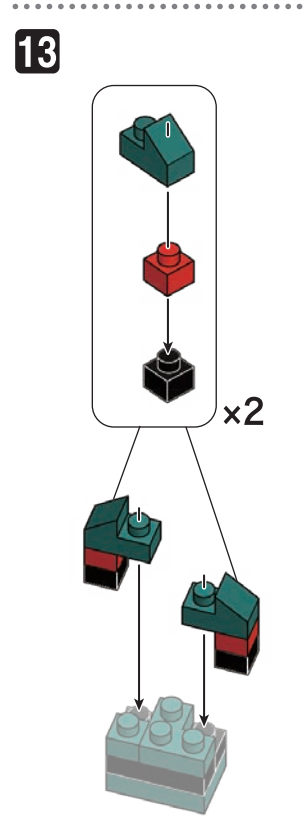
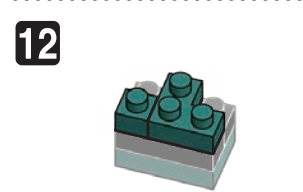
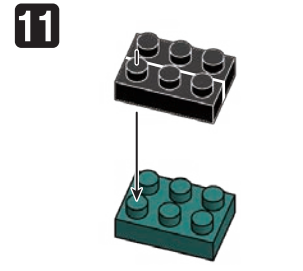
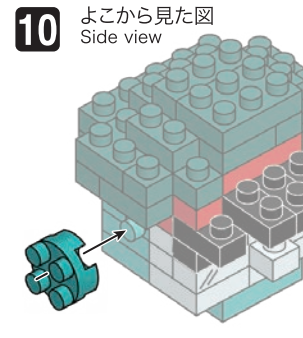
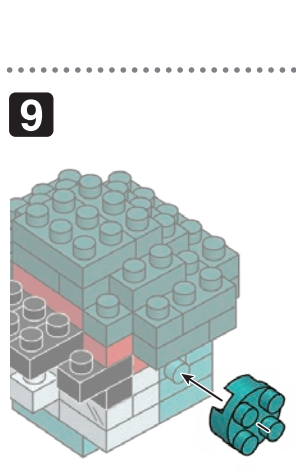
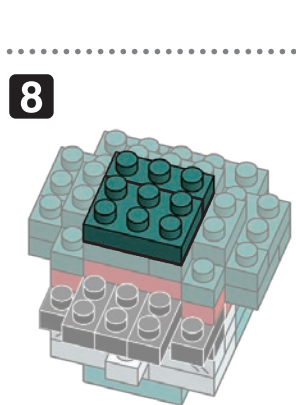
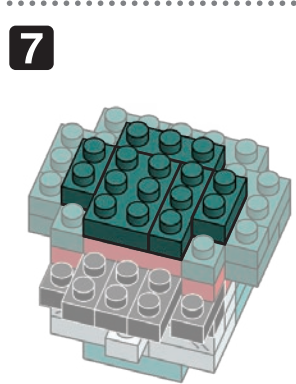
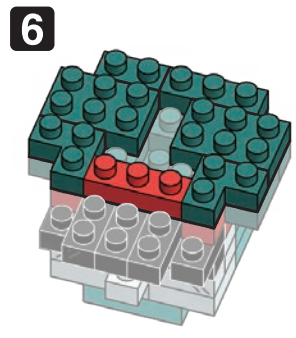
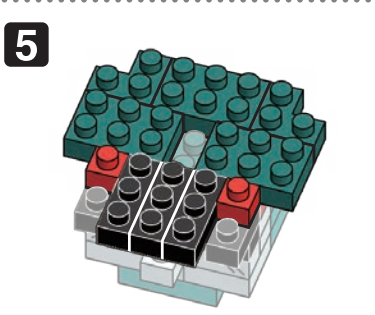
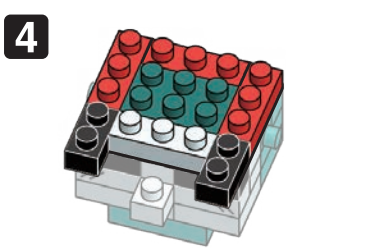
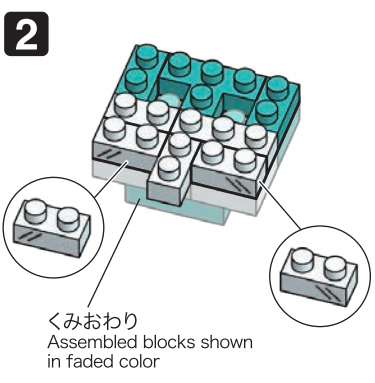
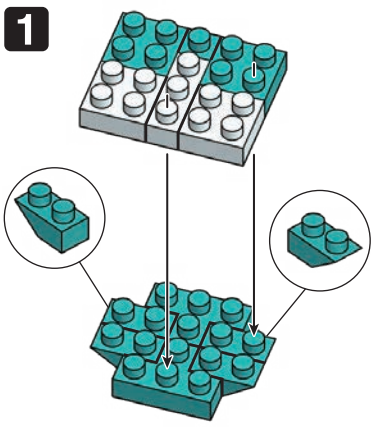

完成!
Finished!

※部品は多めに
入っております
Extra blocks included