

※別売りの「NB-019 ナノブロック専用ピンセット」や「NB-020 ナノブロックパッド」を使うと組み立て、取りはずしに便利です。  
Use "NB-019 nanoblock® Tweezers" and "NB-020 nanoblock® Pad" (each sold separately) for an easy way to assemble and disassemble blocks.

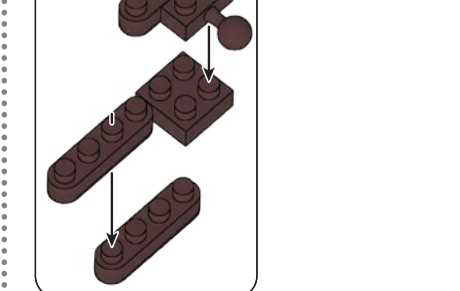

28

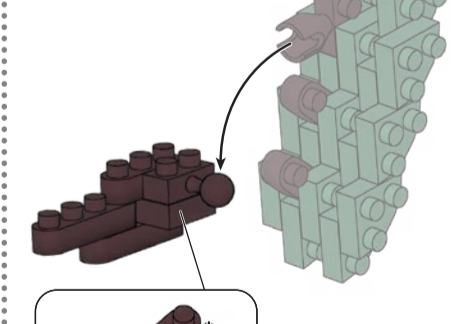
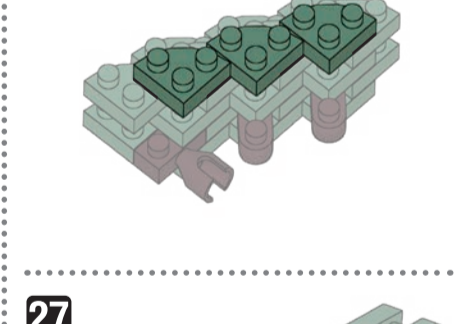
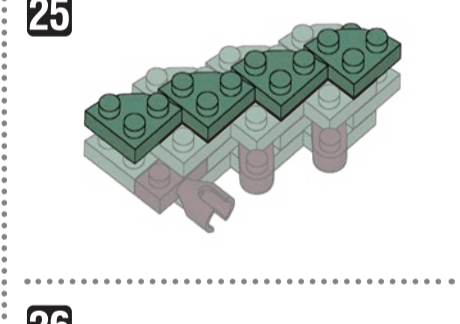
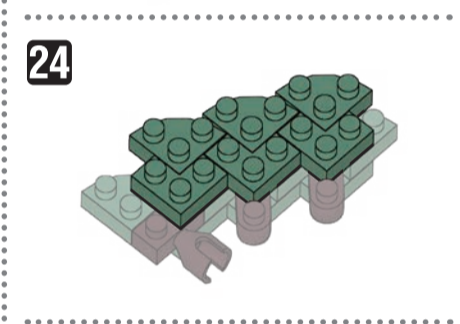
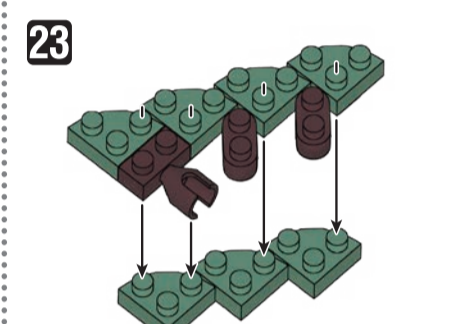
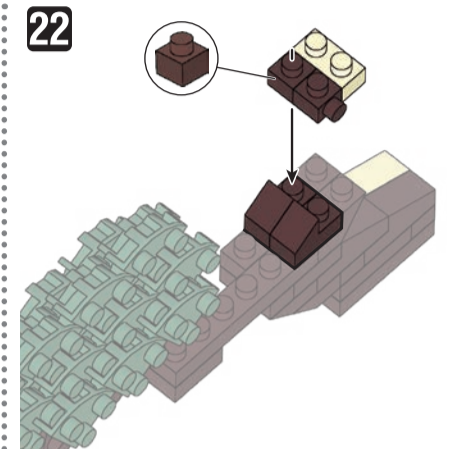
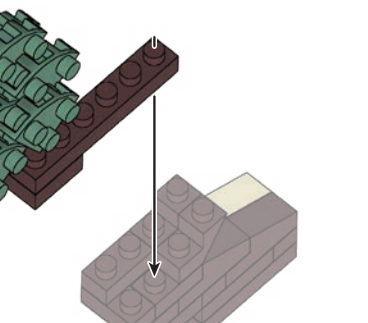
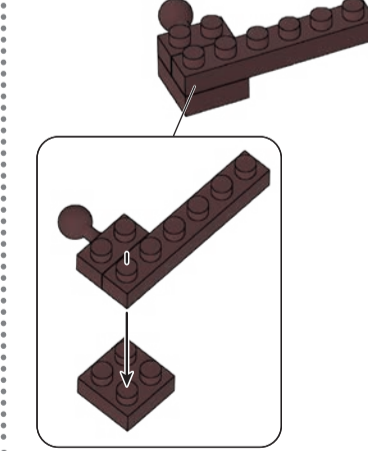
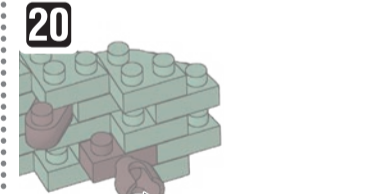
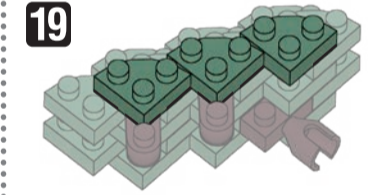
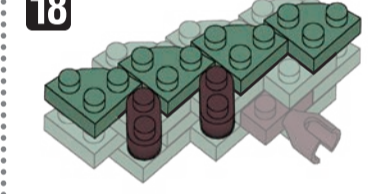
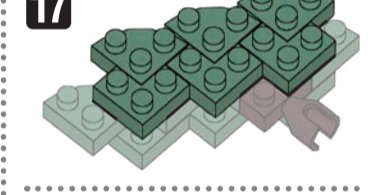
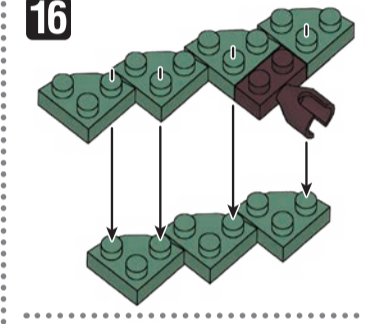
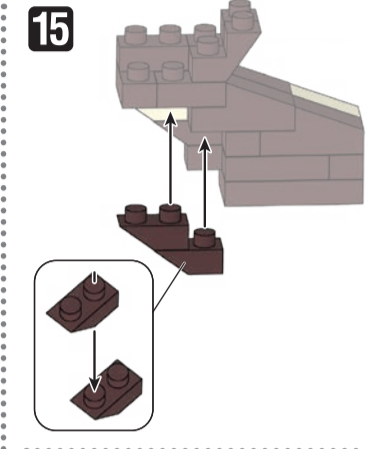
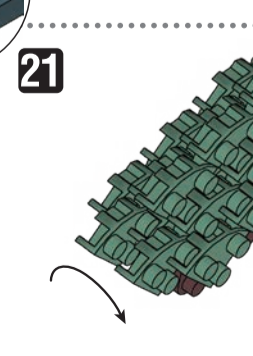
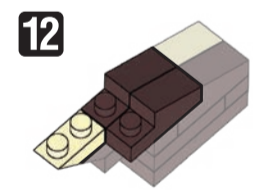
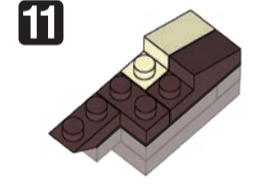
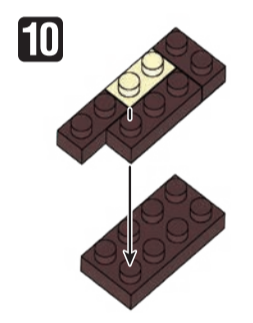
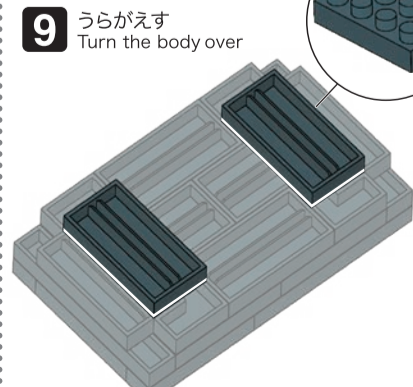
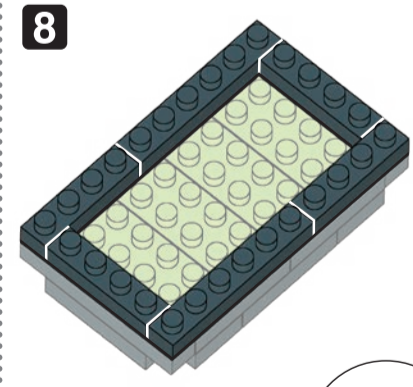
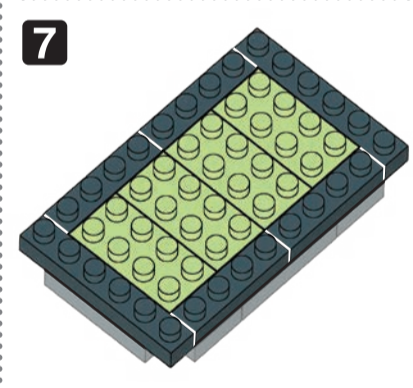
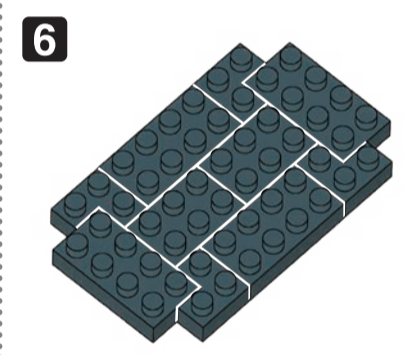
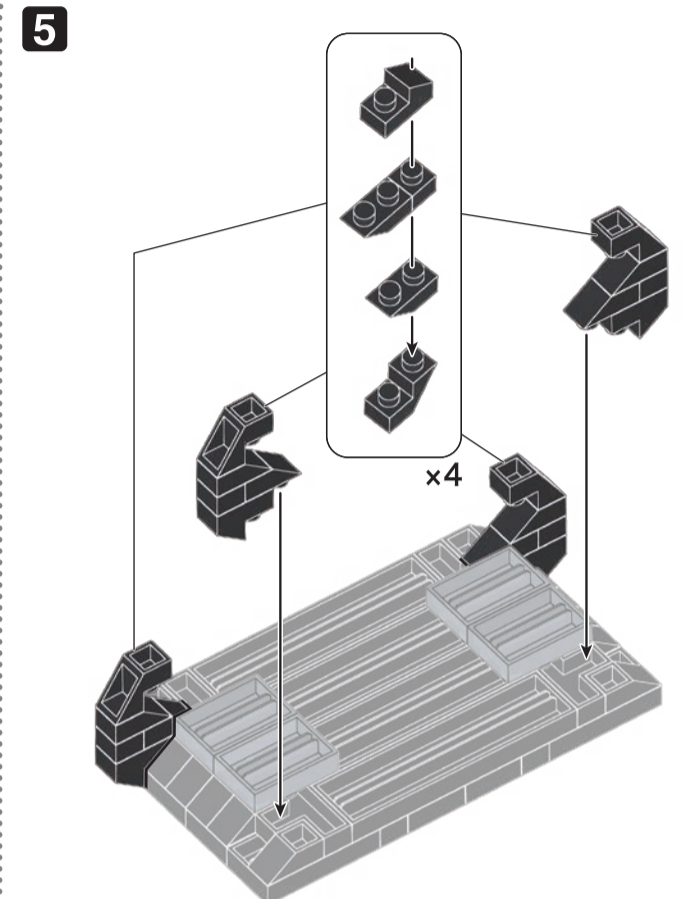
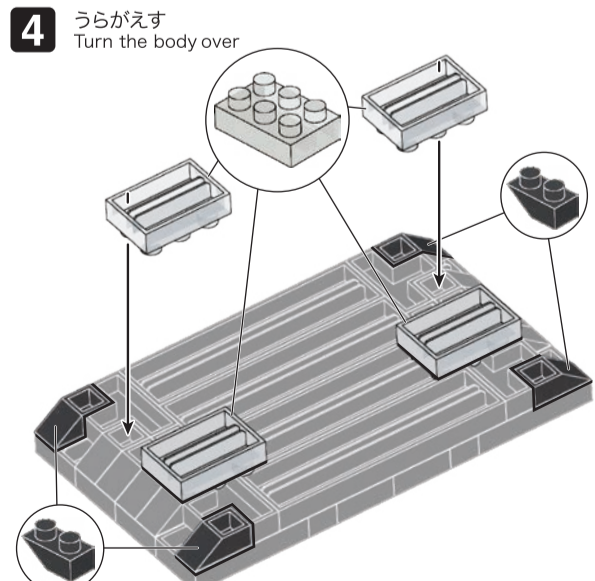
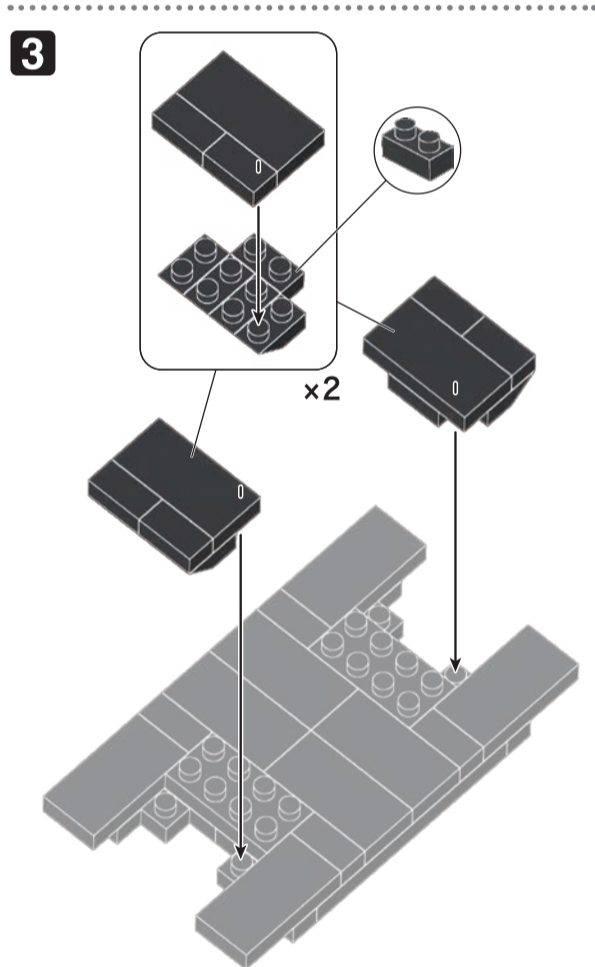
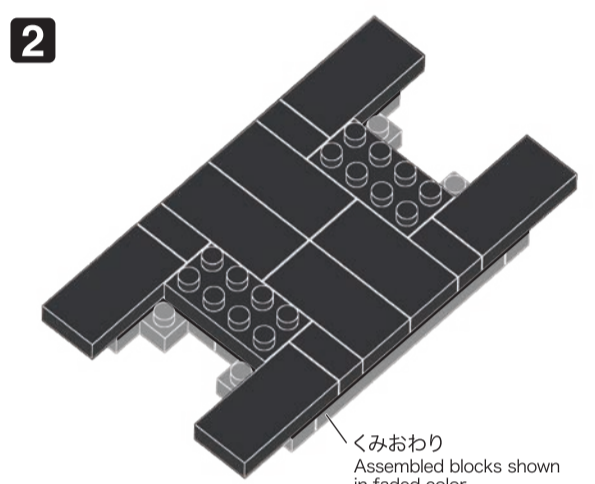
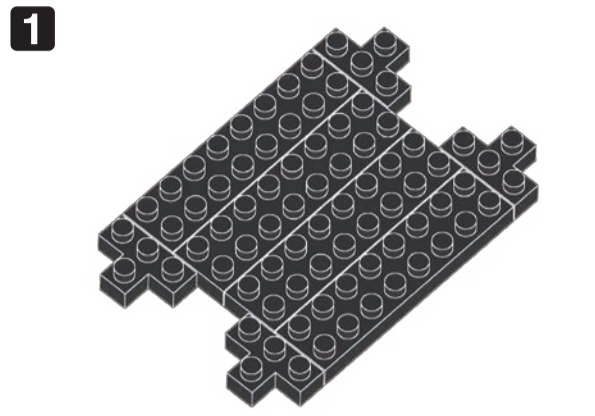
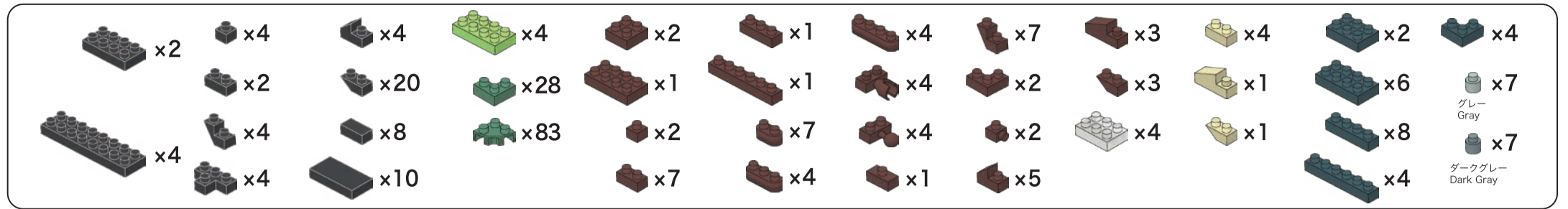
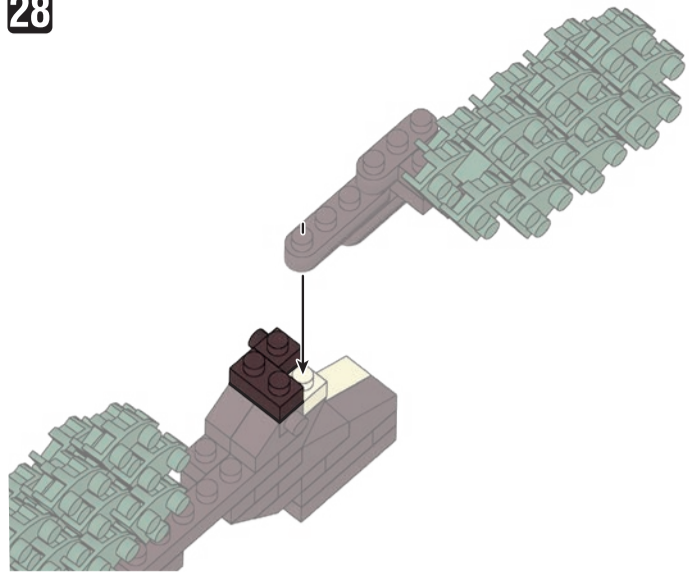

29

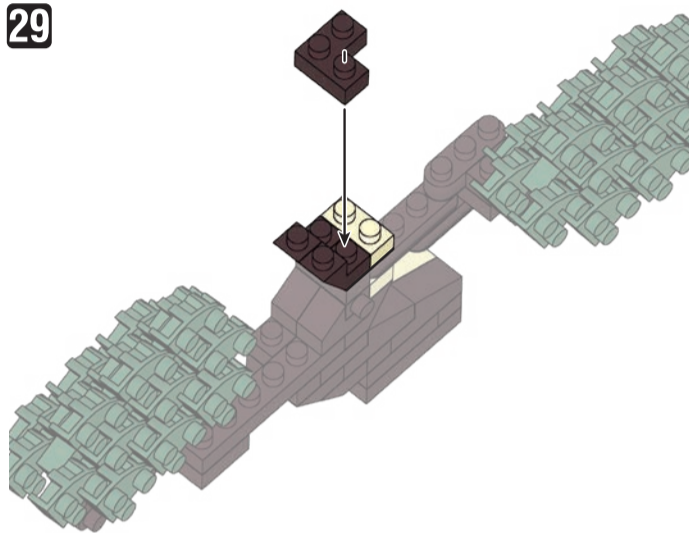

30

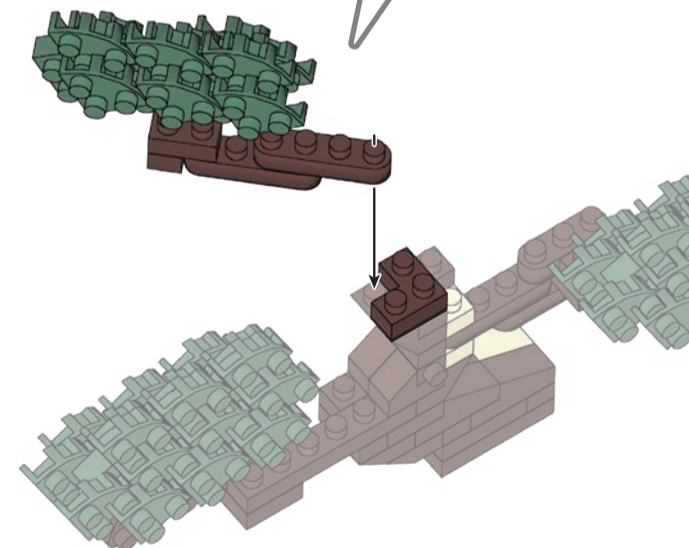
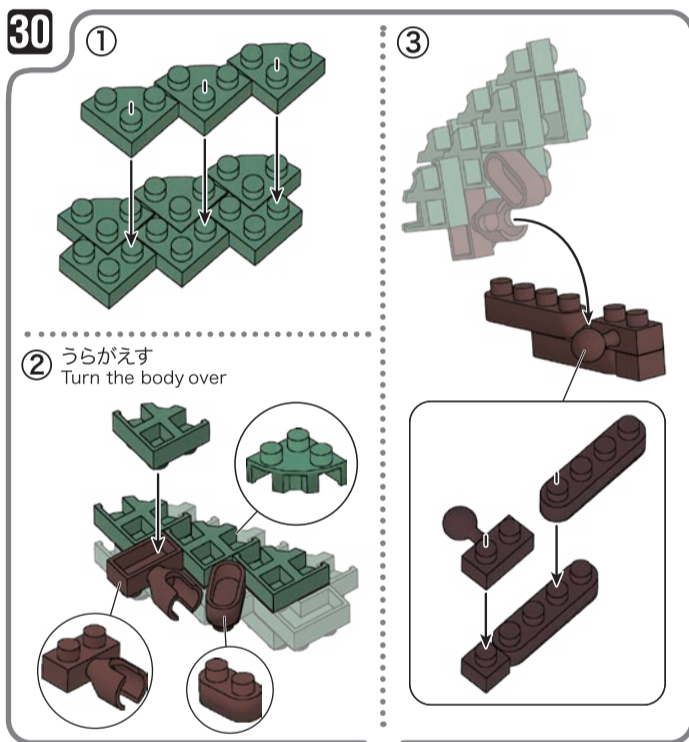

31

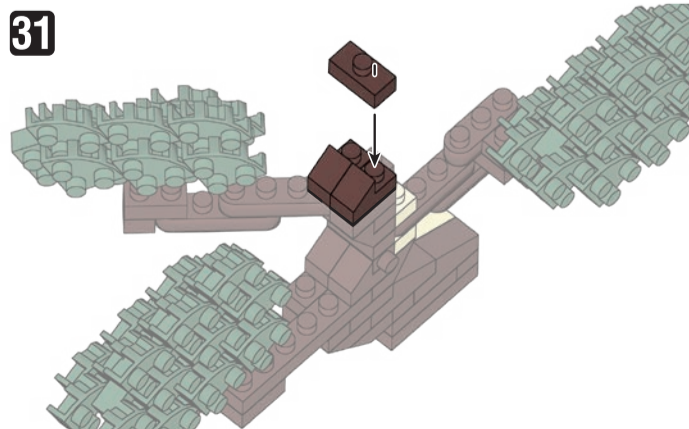

32

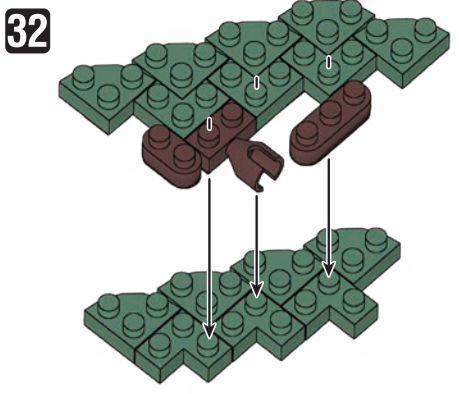

33

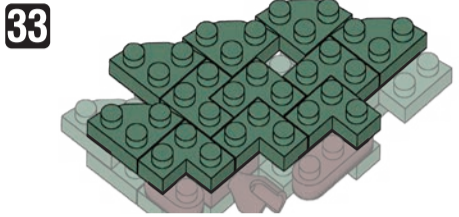

34

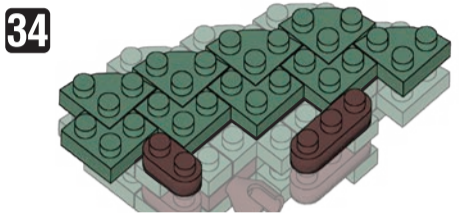

35

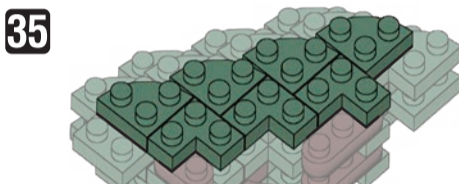

36

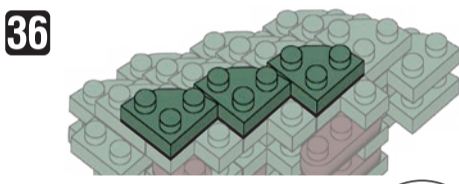

37

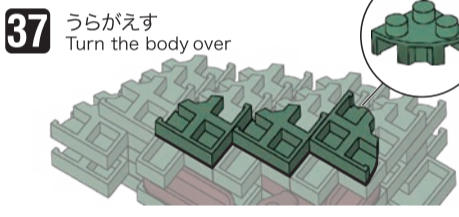

38

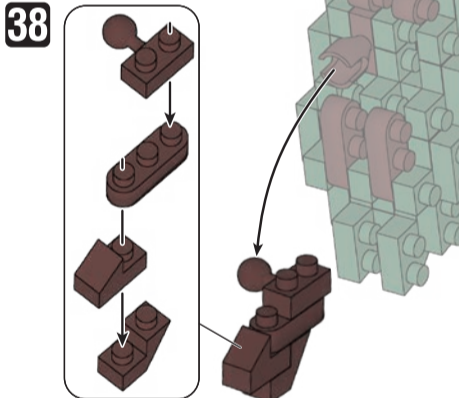

39

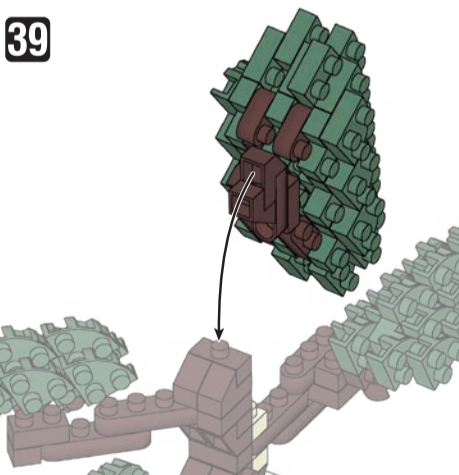

40

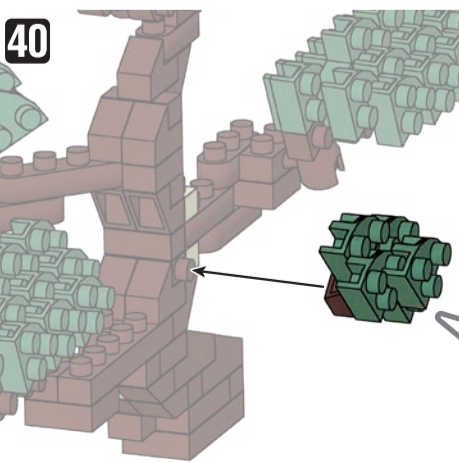

41

反対から見た図  
Opposite side

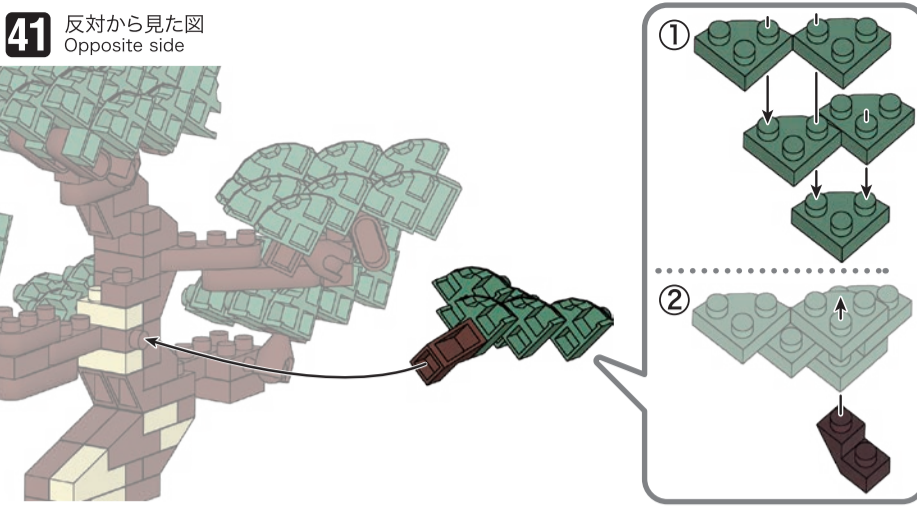

42

もともにもどす  
Turn the body back

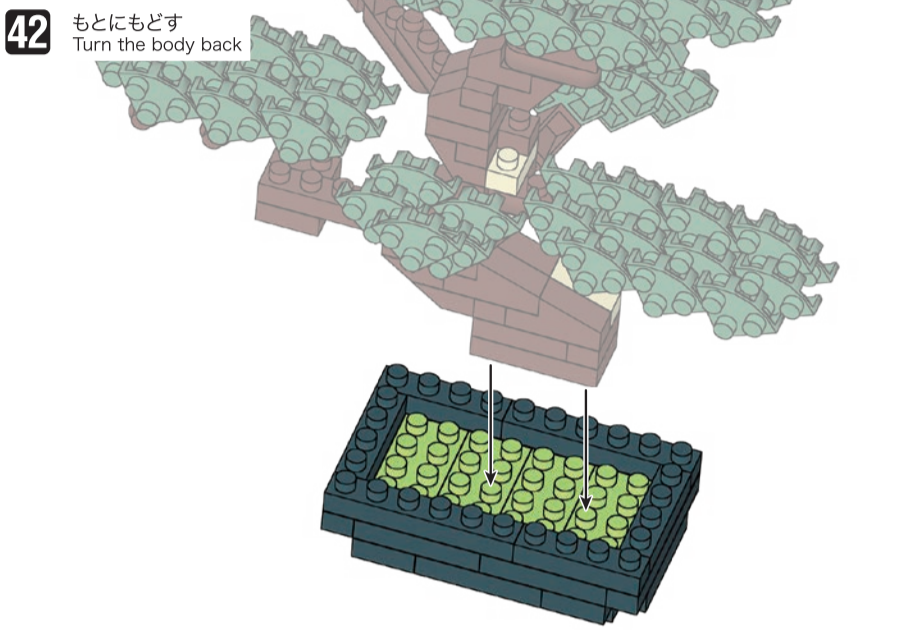

43

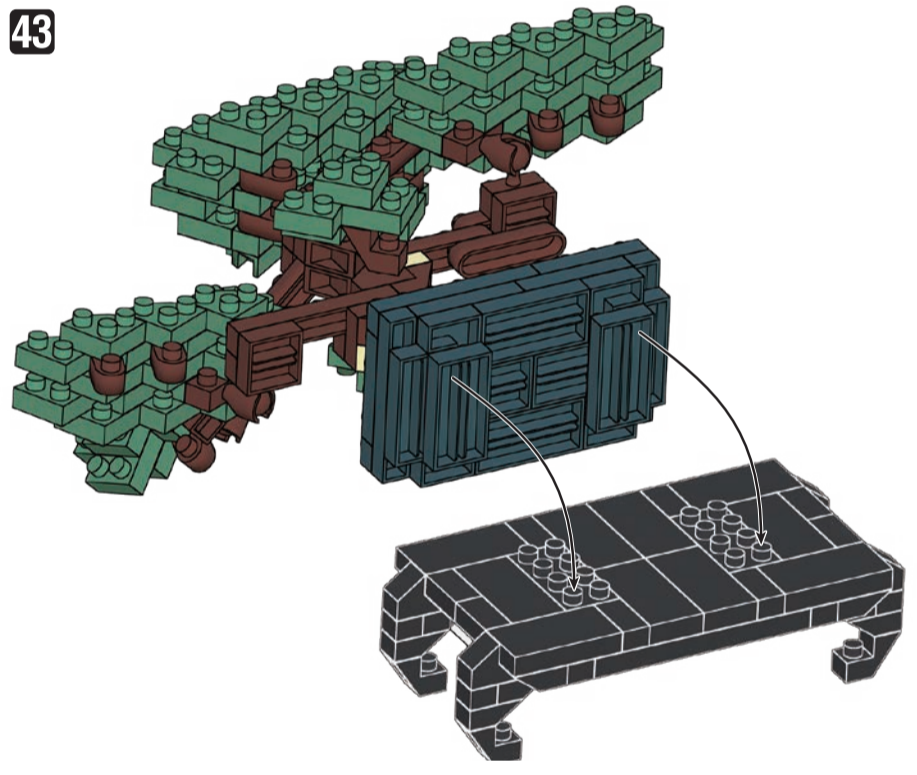

完成!  
Finished!

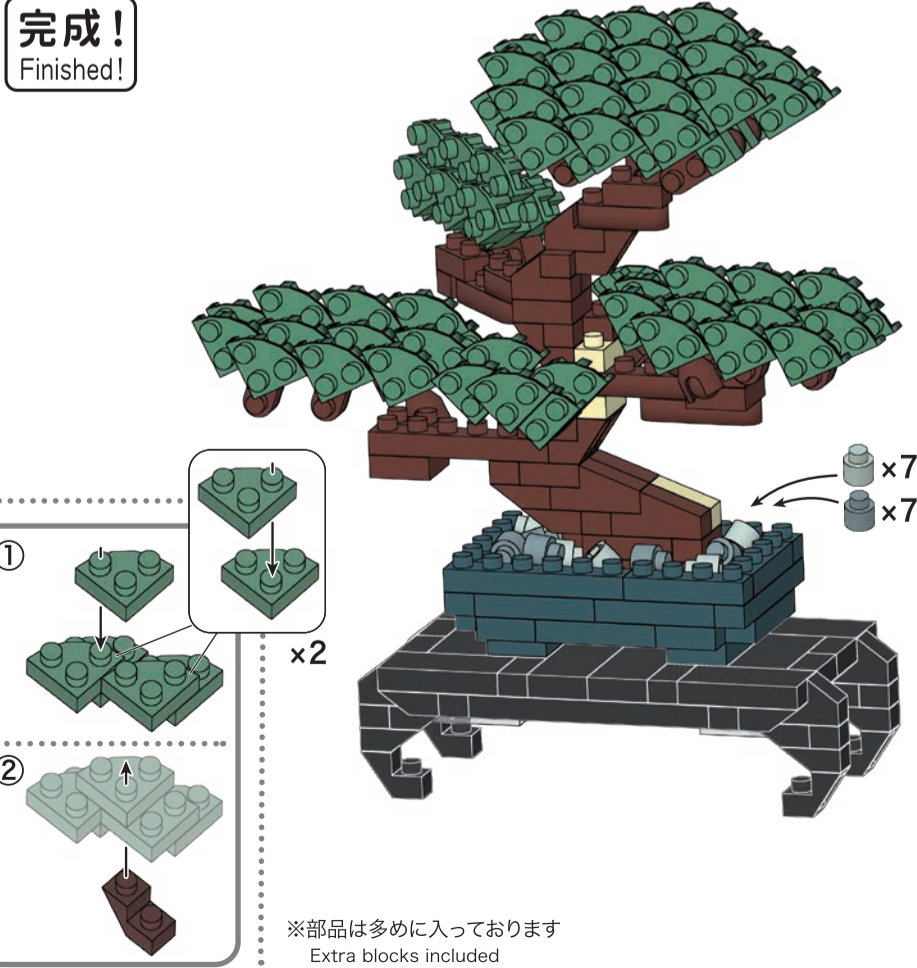

※部品は多めに入っております  
Extra blocks included