

※別売りの「NB-019 ナノブロック専用ピンセット」や「NB-020 ナノブロックパッド」を使うと組み立て、取りはずしに便利です。
Use "NB-019 nanoblock Tweezers" and "NB-020 nanoblock Pad" (each sold separately) for an easy way to assemble and disassemble blocks.

x8	x36	x14	x8	x12	x2	x2	x4	x12	x1	x4	x17	x18	x14	x17
x4	x32	x2	x17	x2	x4	x2	x8	x2	x1	x14	x1	x12	x26	x6
x32	x1	x4	x4	x28	x2	x2	x10	x2	x2	x19	x11	x2	x5	x1
x8	x6	x1	x6	x28	x1	x4	x6	x4	x2	x2	x11	x2	x2	x1

※ 角度の違う2種類の部品に注意してください。
Note that there are two types of blocks, each with different angles.

※ 角度の違う2種類の部品に注意してください。
Note that there are two types of blocks, each with different angles.

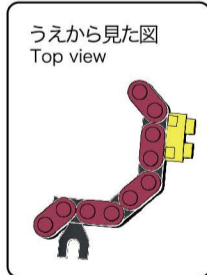
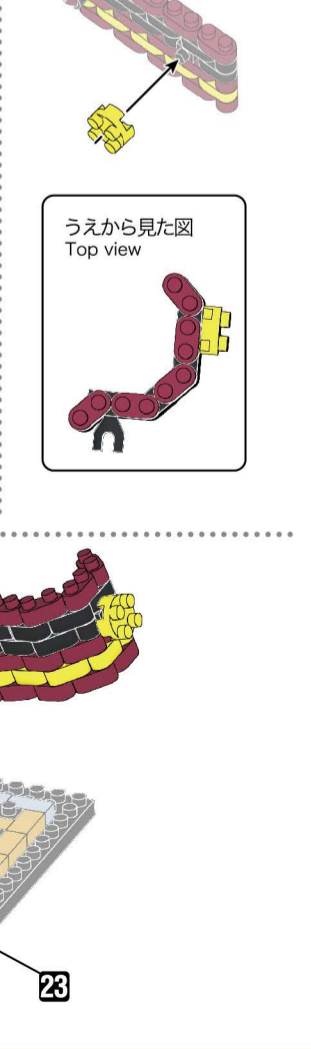
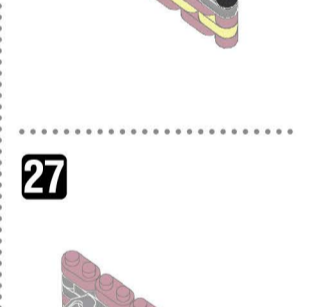
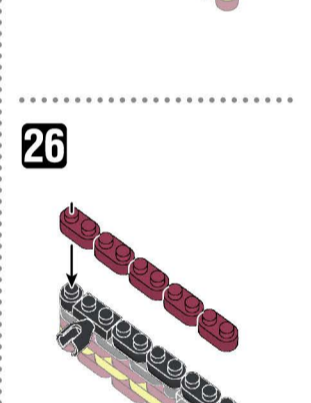
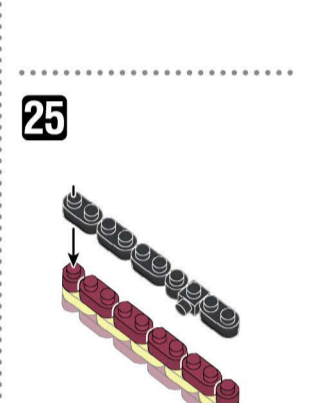
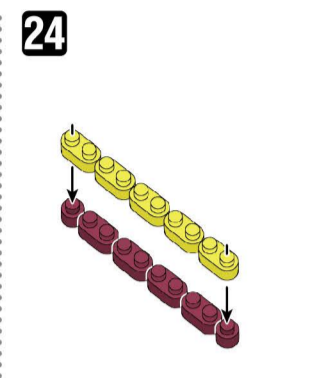
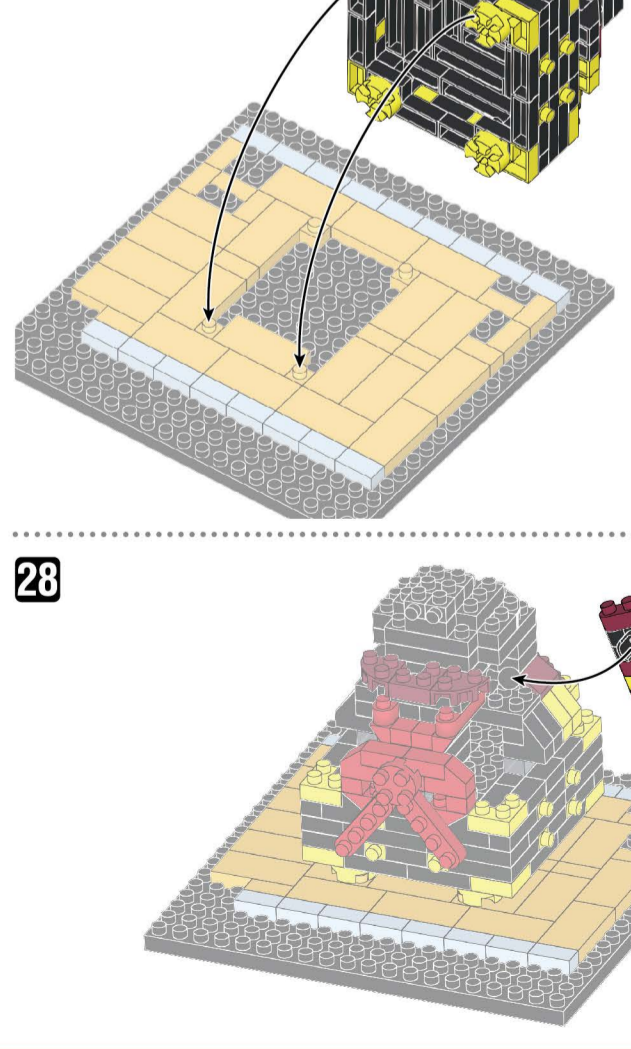
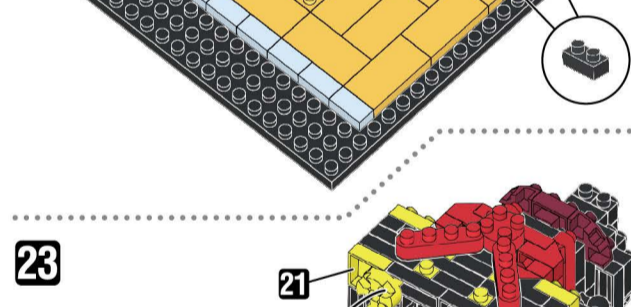
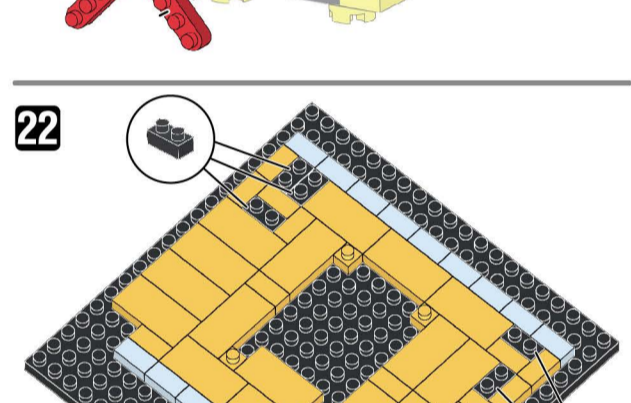
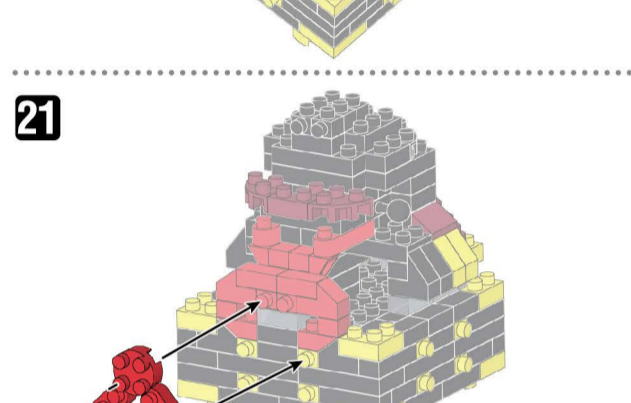
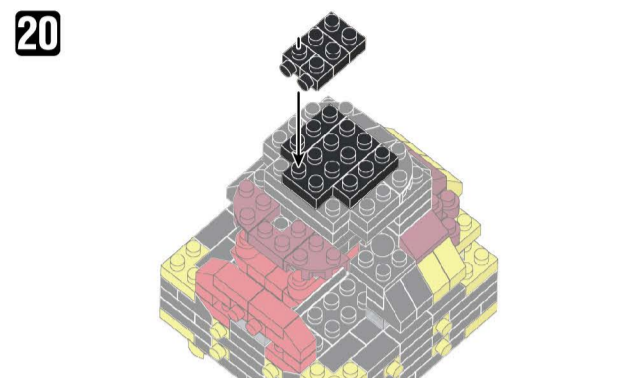
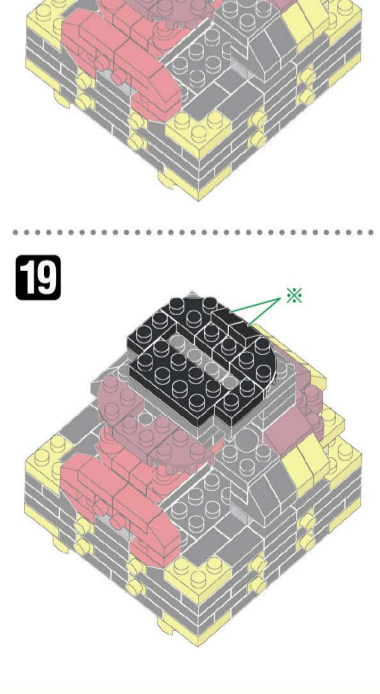
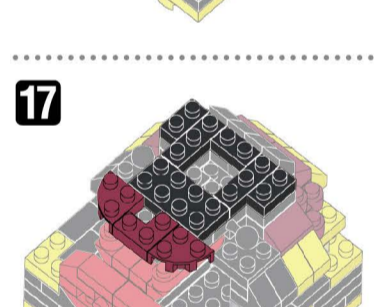
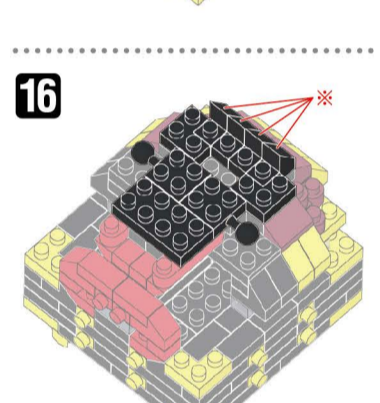
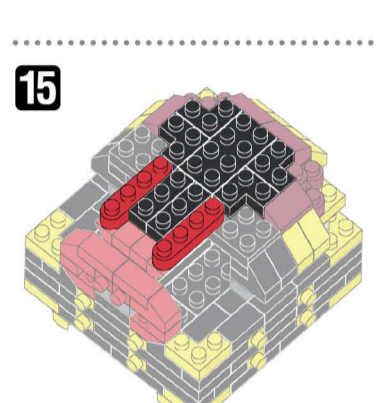
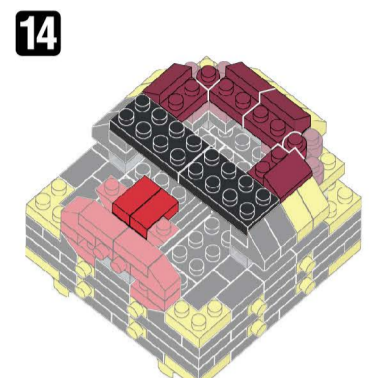
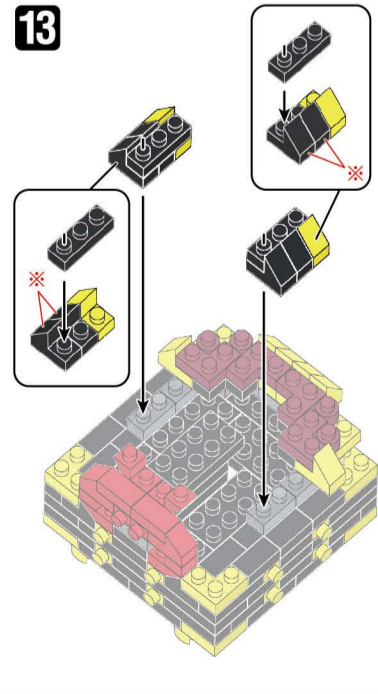
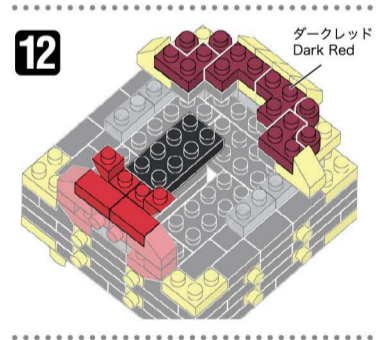
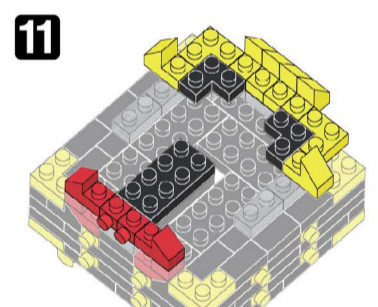
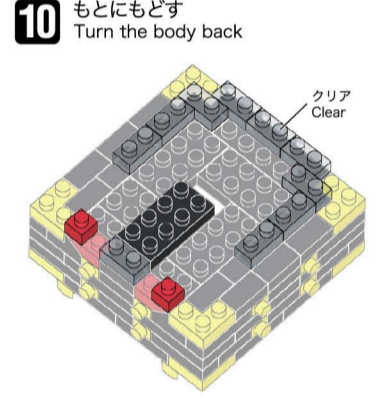
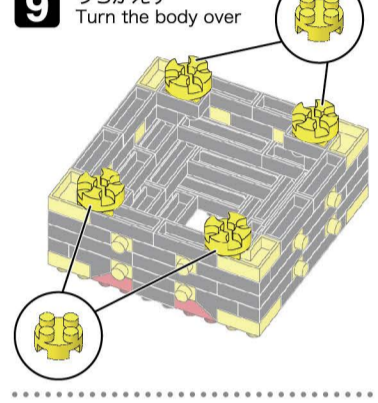
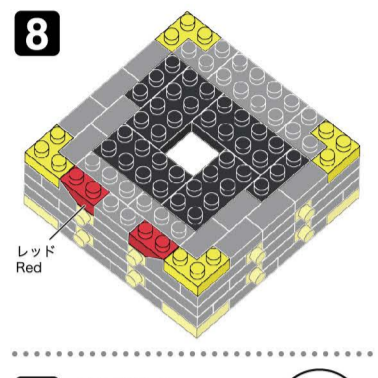
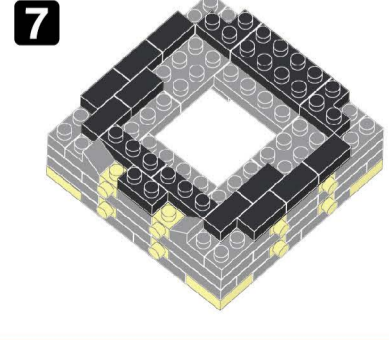
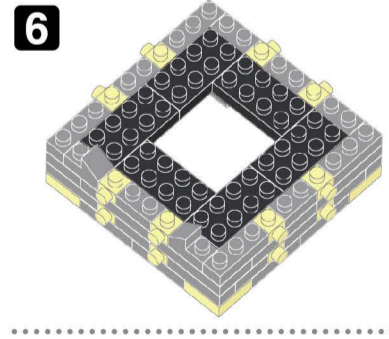
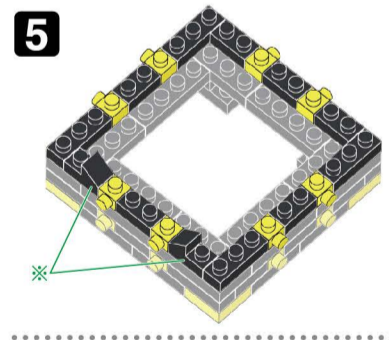
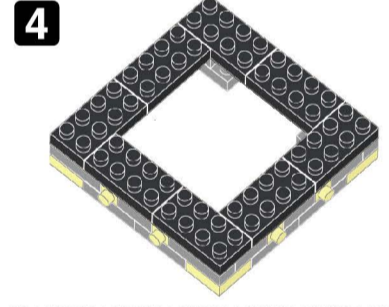
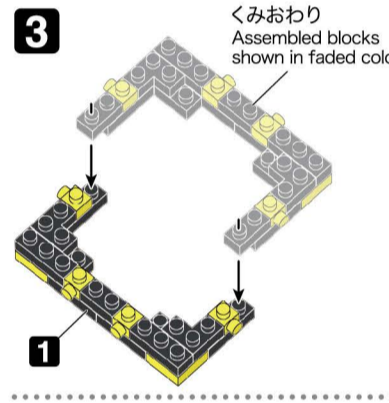
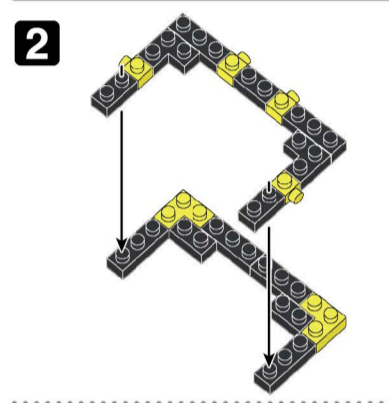
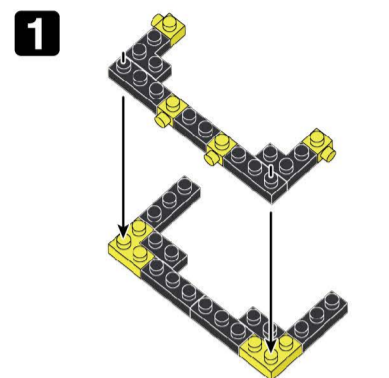

29

ダークレッド
Dark Red

30

33

28

34

1

2

1

2

1

2

1

2

うらがえす
Turn the body over

35

33

31

32

うえから見た図
Top view

36

1

2

3

4

x6

x7

ゴールドブラウン
Gold Brown

x12

37

ブラウン
Brown

クリア
Clear

38

x6

x2

39

1

2

x6

x2

40

1

2

3

4

5

6

クリアブラウン
Clear Brown

ゴールドブラウン
Gold Brown

クリアブラウン
Clear Brown

ゴールドブラウン
Gold Brown

クリアブラウン
Clear Brown

41

1

2

御免

完成!
Finished!

御免

※部品は多めに入っております
Extra blocks included